

CR1620

■ Dimensions(mm)

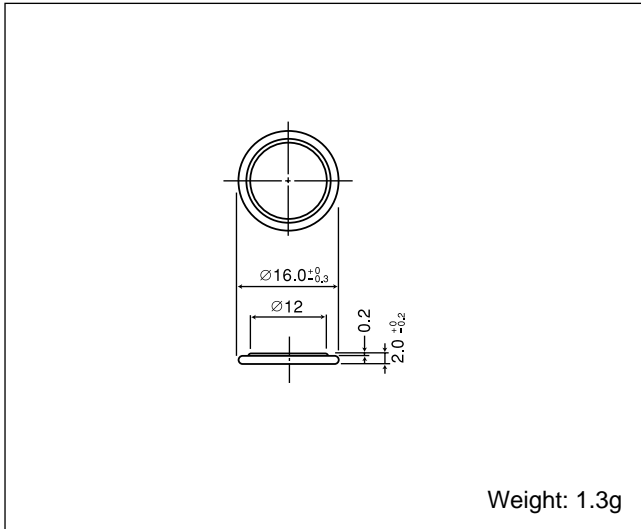

■ Specification

Nominal voltage(V)	3
Nominal capacity(mAh)	75
Continuous standard load(mA)	0.1
Operating temperature(°C)	-30 ~ +60

■ Temperature Characteristics

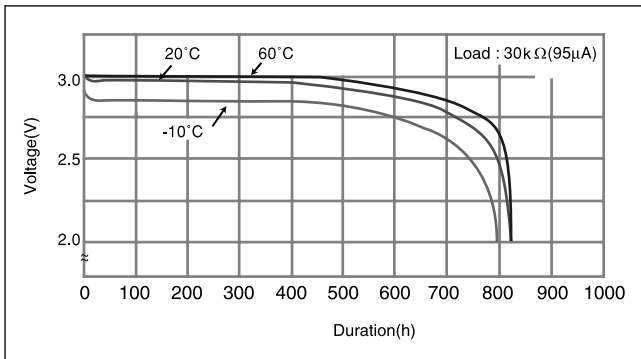

■ Operating voltage vs. load resistance(voltage at 50% discharge depth)

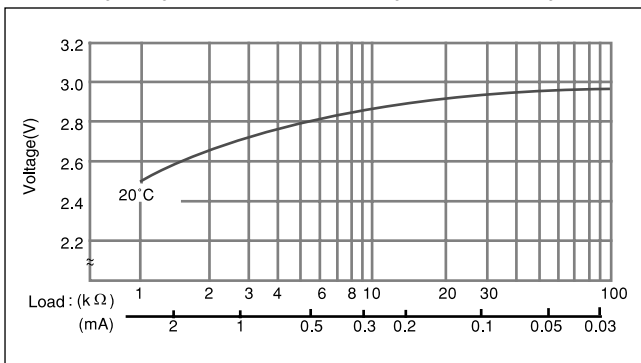

■ Capacity vs. load resistance

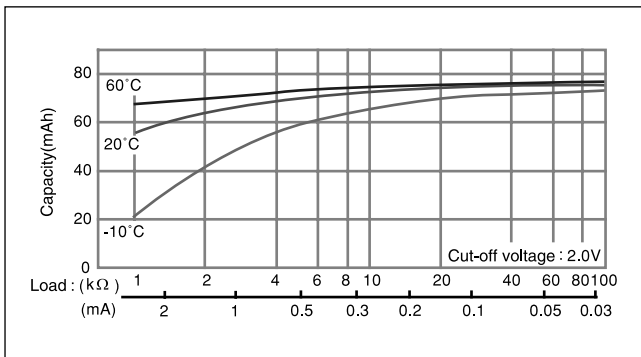

CR1632

■ Dimensions(mm)

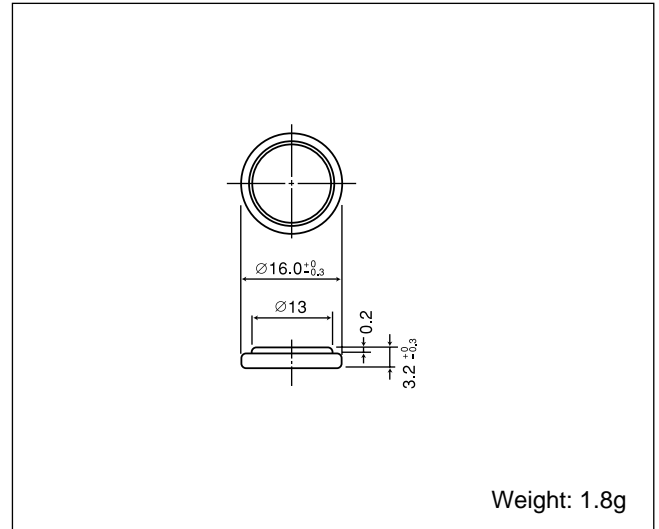

■ Specification

Nominal voltage(V)	3
Nominal capacity(mAh)	125
Continuous standard load(mA)	0.1
Operating temperature(°C)	-30 ~ +60

■ Temperature Characteristics

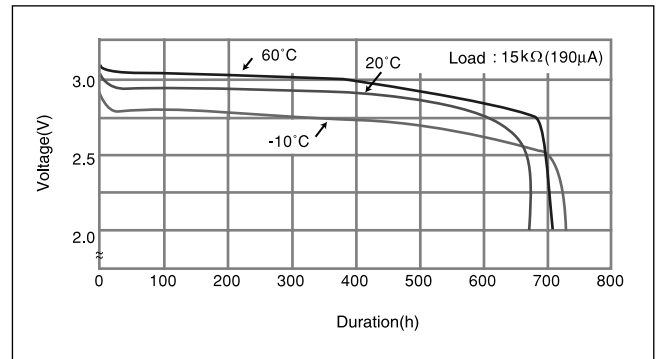

■ Operating voltage vs. load resistance(voltage at 50% discharge depth)

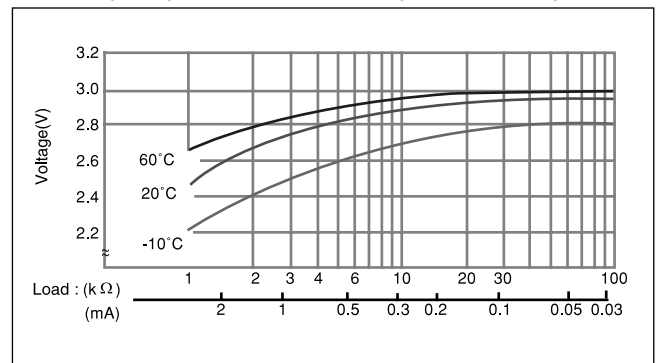

■ Capacity vs. load resistance

